

Owner's Manual

Ceiling Fan Installation Instructions

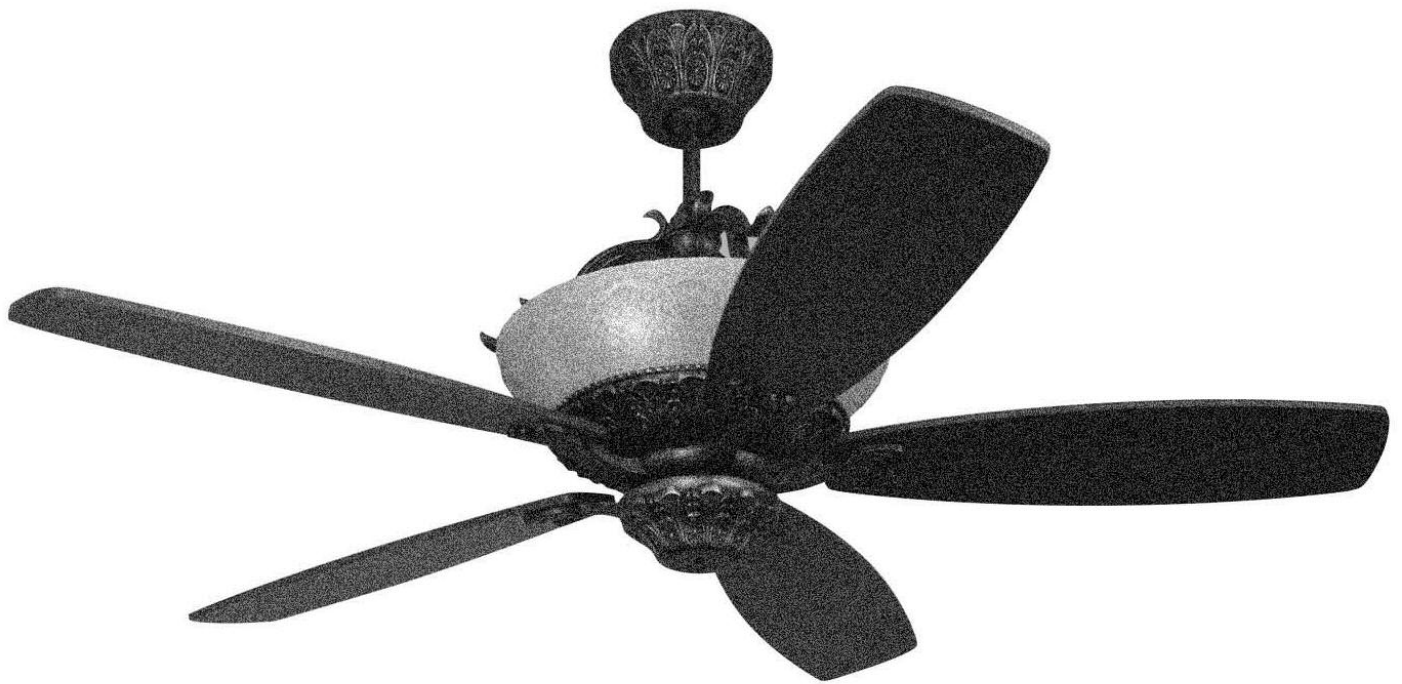

Total fan
weight

For 5RDR Series Fans

BLADES NOT INCLUDED

READ AND SAVE THESE INSTRUCTIONS

MONTE CARLO
Quality Ceiling fans



Installation

SAFETY TIPS

WARNING: TO REDUCE THE RISK OF FIRE, ELECTRIC SHOCK, OR INJURY TO PERSONS, OBSERVE THE FOLLOWING: READ AND SAVE THESE INSTRUCTIONS

1. Installation work and electrical wiring must be done by qualified person(s) in accordance with applicable codes and standards (ANSI/NFPA 70-1999), including fire-rated construction.
2. Use this unit only in the manner intended by the manufacturer. If you have any questions contact the manufacturer.
3. After making the wire connections, the wires should be spread apart with the grounded conductor and the equipment-grounding conductor on one side of the outlet box and ungrounded conductor on the other side of the outlet box.
4. Before you begin installing the fan, Switch power off at Service panel and lock service disconnecting means to prevent power from being switched on accidentally. When the service disconnecting means cannot be locked, securely fasten a prominent warning device, such as a tag, to the service panel.
5. Be cautious! read all instructions and safety information before installing your new fan. Review the accompanying assembly diagrams.
6. When cutting or drilling into wall or ceiling, do not damage electrical wiring and other hidden utilities.
7. Make sure the installation site you choose allows the fan blades to rotate without any obstructions. Allow a minimum clearance of 7 feet from the floor to the trailing edge of the blade.
8. **WARNING – Risk of fire, electric shock, or personal injury,** The fan in this box may be either directly supported from a structural framing member of a building and/or may be mounted to an outlet box marked acceptable for fan support of 31.8 kg. (70 lbs.) or less. Most outlet boxes commonly used for the support of luminaires may not be acceptable for fan support and may need to be replaced. Consult a qualified electrician if in doubt.
9. Do not bend blade holders during installation to motor, balancing or during cleaning. Do not insert foreign object between rotating blades.
10. Attach the mounting bracket using only the hardware supplied with the outlet box.
11. To reduce the risk of fire or electric shock, do not use this fan with any solid state fan speed control device, or variable speed control.
12. If this unit is to be installed over a tub or shower, it must be marked as appropriate for the application.
13. NEVER place a switch where it can be reached from a tub or shower.
14. The combustion airflow needed for safe operation of fuel-burning equipment may be affected by this unit's operation. Follow the heating equipment manufacturer's guideline safety standards such as those published by the National Fire Protection Association (NFPA), and the American Society for Heating, Refrigeration and Air Conditioning Engineers (ASHRAE) and the local code authorities.
15. Before servicing or cleaning unit, Switch power off at Service panel and lock service disconnecting means to prevent power from being switched on accidentally. When the service disconnecting means cannot be locked, securely fasten a prominent warning device, such as a tag, to the service panel.

TOOLS REQUIRED

Phillips Screwdriver

Wire Cutters

Pliers

Step Ladder



1
Before you begin installing the fan, Switch power off at Service panel and lock service disconnecting means to prevent power from being switched on accidentally. When the service disconnecting means cannot be locked, securely fasten a prominent warning device, such as a tag, to the service panel.

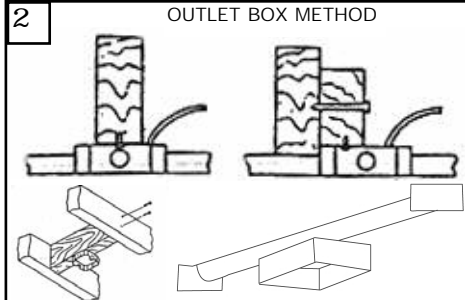

2 **OUTLET BOX METHOD**
Warning-Risk of fire, electric shock, or personal injury. The fan in this box may be either directly supported from a structural framing member of a building and/or may be mounted to an outlet box marked acceptable for fan support of 31.8 kg (70 lbs) or less. Most outlet boxes commonly used for the support of luminaires may not be acceptable for fan support and may need to be replaced. Consult a qualified electrician if in doubt.

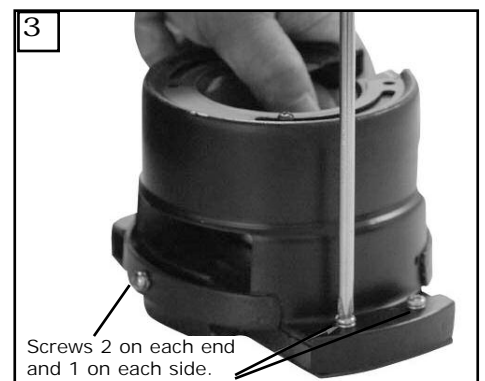

3
Remove the 6 screws attaching the Mounting neck from the mounting plate. Retain the 6 screws for re-assembly.



4
Twist mounting neck and remove from mounting plate.

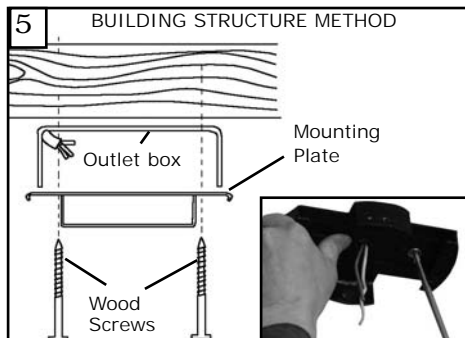

5 **BUILDING STRUCTURE METHOD**
Secure mounting plate directly to a joist from the building structure via the two knock out holes on the outlet box. Use only the appropriate wood screws and washers included with your fan. Caution: Wood screws must go through into the building joist.

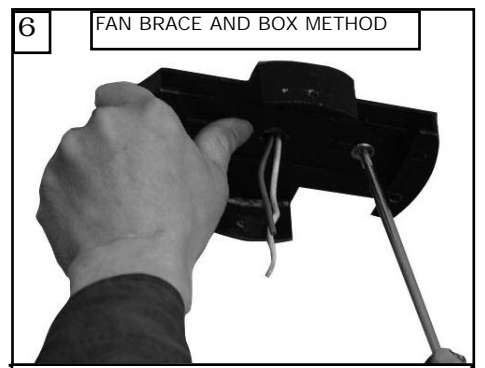

6 **FAN BRACE AND BOX METHOD**
Install the mounting Plate to approved fan brace and box combination use only the hardware provided with the fan brace and box.



Lift mounting neck to mounting Plate and align screws.



Secure mounting neck to the mounting plate with 6 screws to become a complete mounting bracket.



Lower upper glass disk onto fan housing and align 3 holes in glass with 3 holes in fan housing.

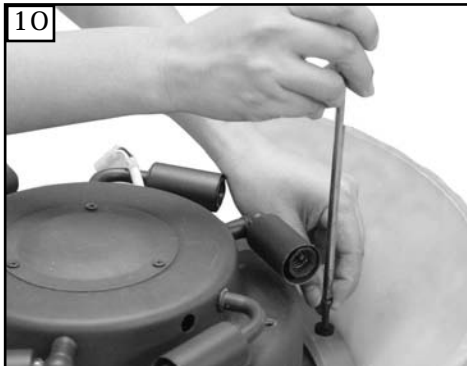

Install 3 screws to hold glass to fan housing. Do not overtighten as this could crack the glass.

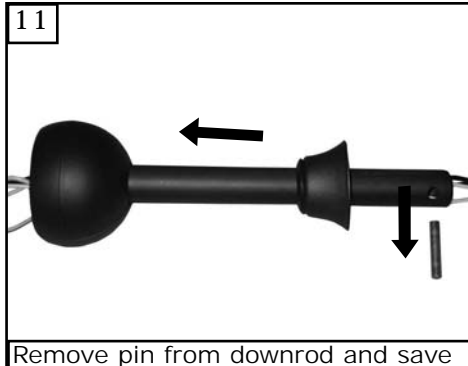

Remove pin from downrod and save for later step 14. Push the yoke cover onto downrod. Thread lead wires and safety cable through the downrod.

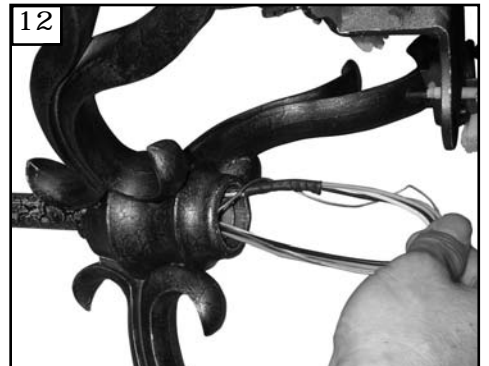

Pull lead wires and safety cable out from the yoke about 3".

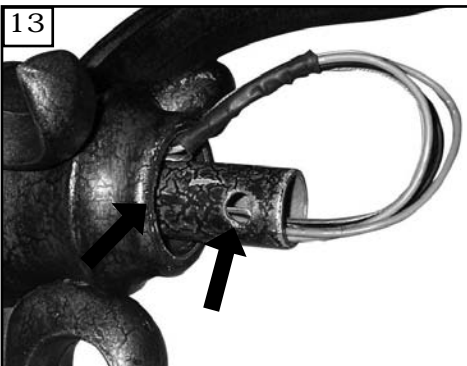

Place downrod into the arch yoke and align the slot in arch yoke and the hole in the downrod.

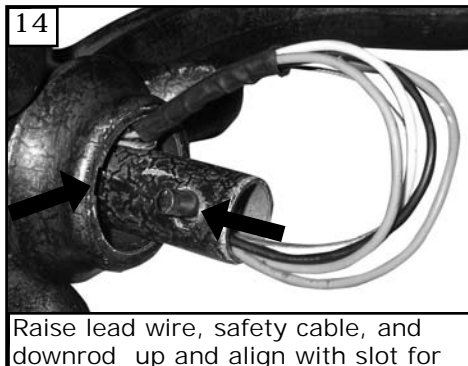

Raise lead wire, safety cable, and downrod up and align with slot for pin in bottom of arch yoke. Push pin into hole in downrod. After putting in pin don't twist downrod. Make sure pin is fully engaged in slot.



Tighten set screws to hold downrod securely in the arch yoke.

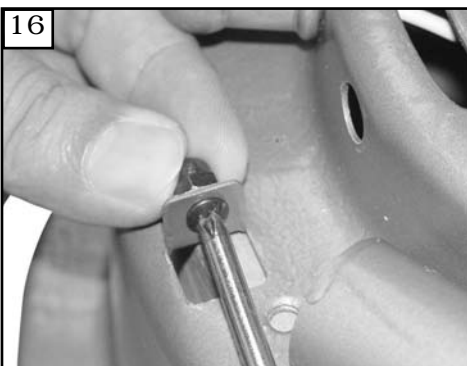

Remove screw and nut on tab to place arch arms in place. Save screw and nut for use later step 19.



Place arms over the fan housing. Make sure the arms with electrical connection plugs are next to the plugs on the fan housing.

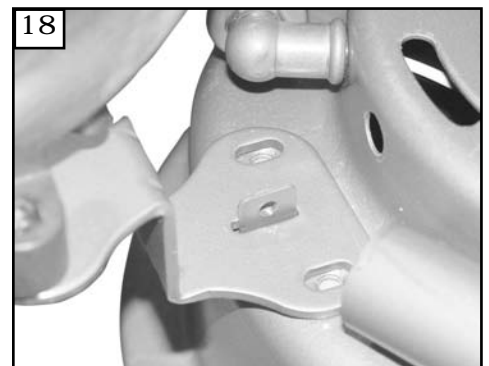

Close up for showing tab and screw holes of fan body to place arch arms over for arch installation.

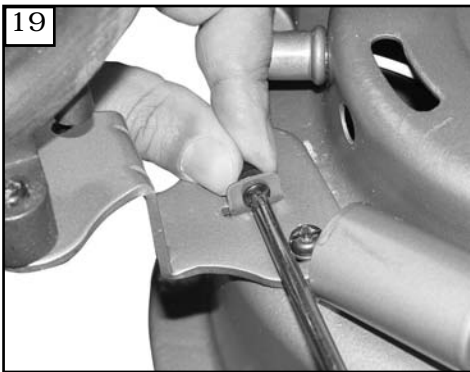

19
Install arch mount by using screw and nut removed in step 16. Place screw through tab and tighten nut and screw securely.



20
Align holes in arch arm and slot for tab with holes and tab on fan body. Start all screws in the arch arm brackets.

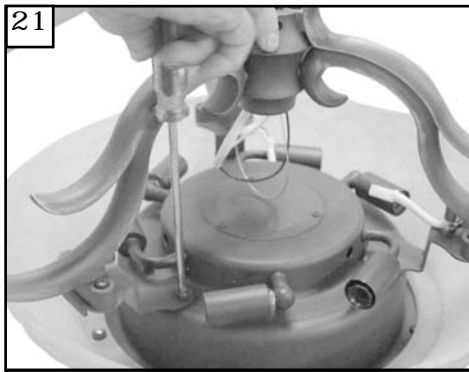

21
Tighten all 6 screws for arch arms securely.

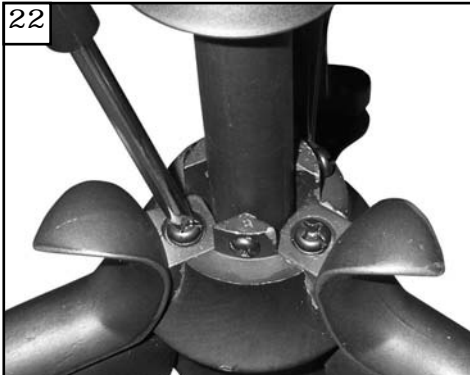

22
Tighten the 3 screws holding the arch arms securely.

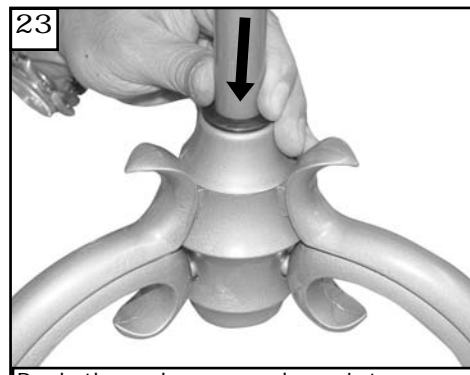

23
Push the yoke cover down into place.

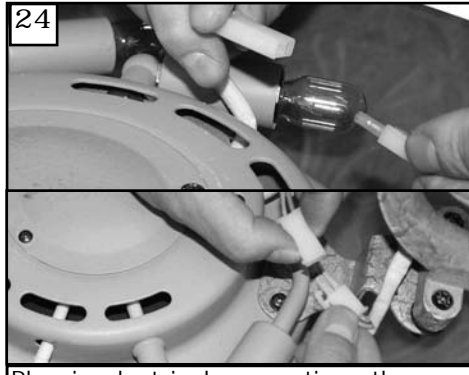

24
Plug in electrical connections there are 2 double plugs from arch assembly one for the fan and one for the up and down lights.



25
Install 6 x 15 watt candelabra torpedo shape bulbs.



26
Install decorative cap.



27
Thread leadwires and safety cable through the canopy. Place canopy over the downrod.

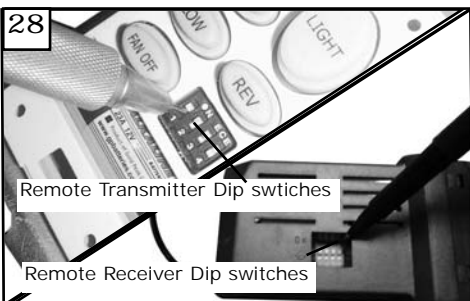

28
Remote Transmitter Dip switches
Remote Receiver Dip switches
Set dip switches on the Remote Transmitter and Remote Receiver to the same settings. This must be done so the units will communicate properly. If you have other fans you can set to control from one transmitter by setting both receivers the same as the transmitter. If you have more than one fan with remote. You can set the dip switches to different positions to have separate control.

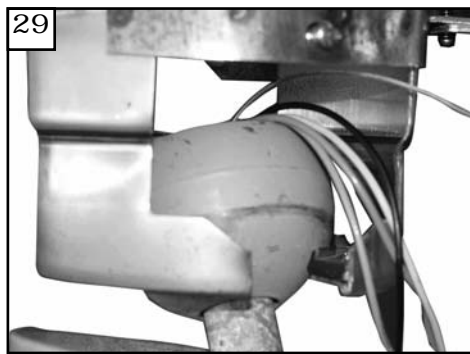

29
Hang assembled fan from the mounting bracket. Make sure the fan is hanging straight. Rotate fan until the tab on the Mounting bracket engages the slot on the Downrod Ball. This must be done to prevent the fan body from rotating when the blades are in motion.



30
Rotate slide on mounting bracket till it stops so the screw holes will align for 2 canopy screws in hardware pack. Tighten the 2 screws securely. These will lock slide in place till ready to mount canopy. (step 34)

31 Canadian mounting only

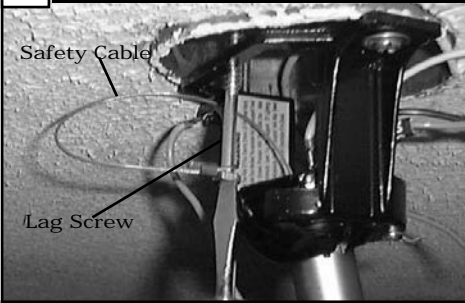

For Canadian installation in both flush and downrod mode the safety cable must be installed into the house structure beams using the 3" lag screws provided. Make sure that when the safety cable is fully extended the leadwires are longer than the cable and no stress is placed on the leadwires.

32

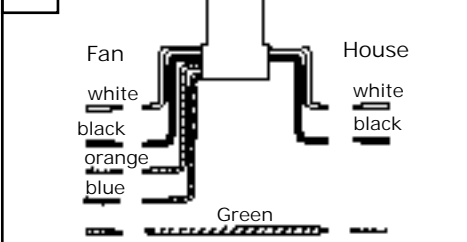

Make wiring connections as indicated above. White from fan to white from remote marked N. Orange from fan to Orange from remote marked Light/up. Blue from fan to blue from remote marked down light. Black from fan to Black from remote marked L. White from house to white from remote marked AC N. Black from house to Black from remote marked AC L. Connect all green ground wires to Ground wire from House.

33



Make wire connections to power source using wire nuts provided. Make sure that no filaments are outside of the wirenut. After making the wire connections, the wires should be spread apart with the grounded conductor and the equipment-grounding conductor on one side of the outlet box and ungrounded conductor on the other side of the outlet box.

34



Lift Canopy to ceiling aligning the key hole slots with the screws on the bottom of the Mounting bracket. Rotate the canopy Counter Clockwise to lock in place. Tighten the screws to secure the Canopy. See inset for Keyhole shape

35

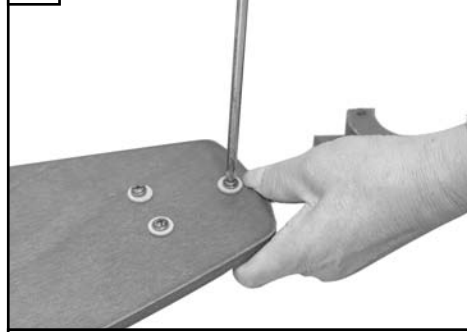

Attach blade brackets to blades using the blade bracket screws and washers provided.

36



Install all 5 fan blade assemblies to the motor as shown above. Tighten screws securely.

37

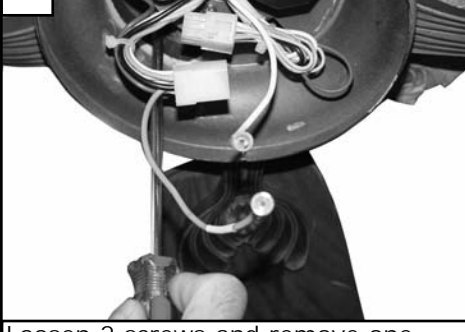

Loosen 2 screws and remove one and save it. Place plate's key slotted holes over the 2 screws loosened and twist into place. Replace removed screws and tighten all 3.

38

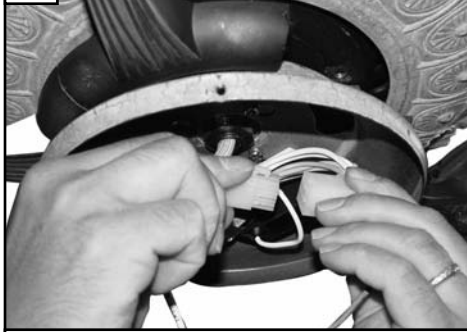

Plug 9 pin wire connections together.

39



Attach switch housing to fan using the three screws provided.

40



Remove cover by snapping off from top or bottom. Install 12V battery into wall remote. Duracell MN21 / Eveready A23 / GP 23A all 12V.

41



Attach cover of remote by placing over buttons and snapping into place.

42

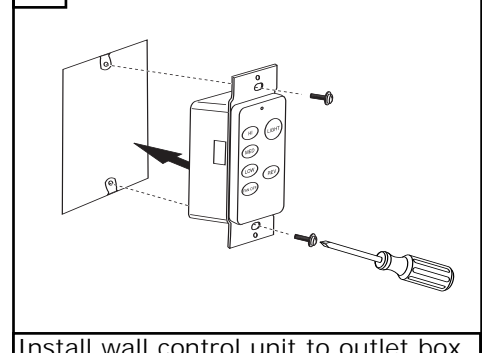

Install wall control unit to outlet box using machine screws provided.

43

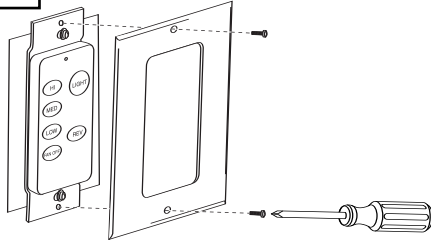

Attach front cover to wall control with screws provided.

44

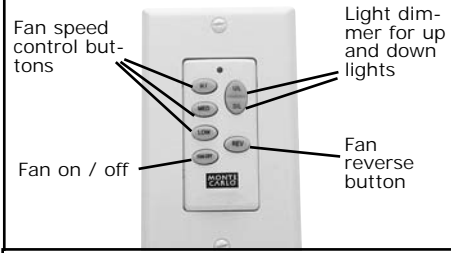

To control fan speed select from High, Medium or low speed buttons. To turn the fan off press the Fan on / off button. To dim upper lights press and hold U/L button. To dim Lower lights press and hold D/L button. To turn off either up or down light press and quickly release either U/L or D/L button. Press button marked REV to reverse the rotation direction of the fan blades

Trouble Shooting

If you have difficulty operating your new ceiling fan, it may be the result of incorrect assembly, installation, or wiring. In some cases, these installation errors may be mistaken for defects. If you experience any faults, please check this Trouble Shooting Chart. If a problem cannot be remedied, or you are experiencing difficulty in installation, please call our Customer Service Center at the number printed on your parts list insert sheet.

Warning: Before servicing or cleaning unit, Switch power off at Service panel and lock service disconnecting means to prevent power from being switched on accidentally. When the service disconnecting means cannot be locked, securely fasten a prominent warning device, such as a tag, to the service panel.

1. If fan does not start:

1. Check main and branch circuit fuses or circuit breakers.
2. Check line wire connections to fan and switch wire connections in switch housing.
3. Check to make sure the dip switches from the transmitter and receiver are set on the same frequency.

CAUTION: Make sure main power is turned off.

2. If fan sounds noisy:

1. Check to make sure all screws in motor housing are snug (not over tightened).
2. Check to make sure the screws which attach the fan blade holder to the motor are tight.
3. Check to make sure wire nut connectors in switch housing are not rattling against each other or against the interior wall of the switch housing.

CAUTION: Make sure main power is turned off before entering switch housing and canopy.

4. Some fan motors are sensitive to signals from Solid State variable speed controls. **DO NOT USE** a Solid State variable speed control.
5. Allow "break-in" period of 24 hours. Most noises associated with a new fan will disappear after this period.

3. If fan wobbles:

1. Make sure that the ridge of the canopy engages the notch in the downrod ball.
2. Check that all blades are screwed firmly into blade holders.
3. Check that all blade holders are tightened securely to motor.
4. Make sure that canopy and mounting bracket are tightened securely to ceiling junction box and junction box is mounted firmly to ceiling joist.
5. Most fan wobble problems are caused when blade levels are unequal. Check this level by selecting a point on the ceiling above the tip of one of the blades. Measure this distance from blade tip to ceiling. Keeping measure within 1/8", rotate the fan until the next blade is positioned for measurement. Repeat for each blade. If all blade levels are not equal, you can adjust blade levels by the following procedure. To adjust a blade tip down, insert a washer (not supplied) between the blade and blade holder at the screw closest to the motor. To adjust a blade tip up, insert washer (not supplied) between the blade and blade holder at the two screws farthest from the motor. Reverse the position of the washer if blades mount from top of blade.
6. If blade wobble is still noticeable, interchanging two adjacent (side by side) blades can redistribute the weight and possibly result in smoother operation.

4. If light does not work:

1. Check wire from fan to make sure it is connected to hot wire from house.
2. Check for loose or disconnected wires in fan switch housing.
3. Check for loose or disconnected wires in light kit.
4. Check for faulty light bulbs.

CAUTION: Make sure main power is turned off before entering switch housing and canopy.

WARNING: Before attempting to replace the fuse make sure the main power is turned off to the fan. Replace only with 3 amp fuse.

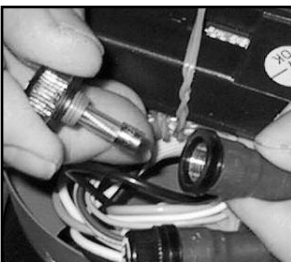

MONTE CARLO

Customer Service Center:
740 S.W. Loop 820, Suite 110
Fort Worth, Texas 76115
1-800-519-4092